

SERIE E-200



Material: Microfusión en acero inoxidable Aisi 304 y Aisi 316.

Acabado: Pulido brillo o satinado.

Soporte: Elemento rígido para la sujeción de nuestros grampones a la estructura portante. Pueden ser graduables, fijos o mixtos. Se pueden fijar a pasamanos por medio de tornillos o soldadura. Igualmente en estructuras cilíndricas o planas. Se fabrican soportes bajo pedido en inox, hierro, aluminio o plástico.

Montaje de soporte

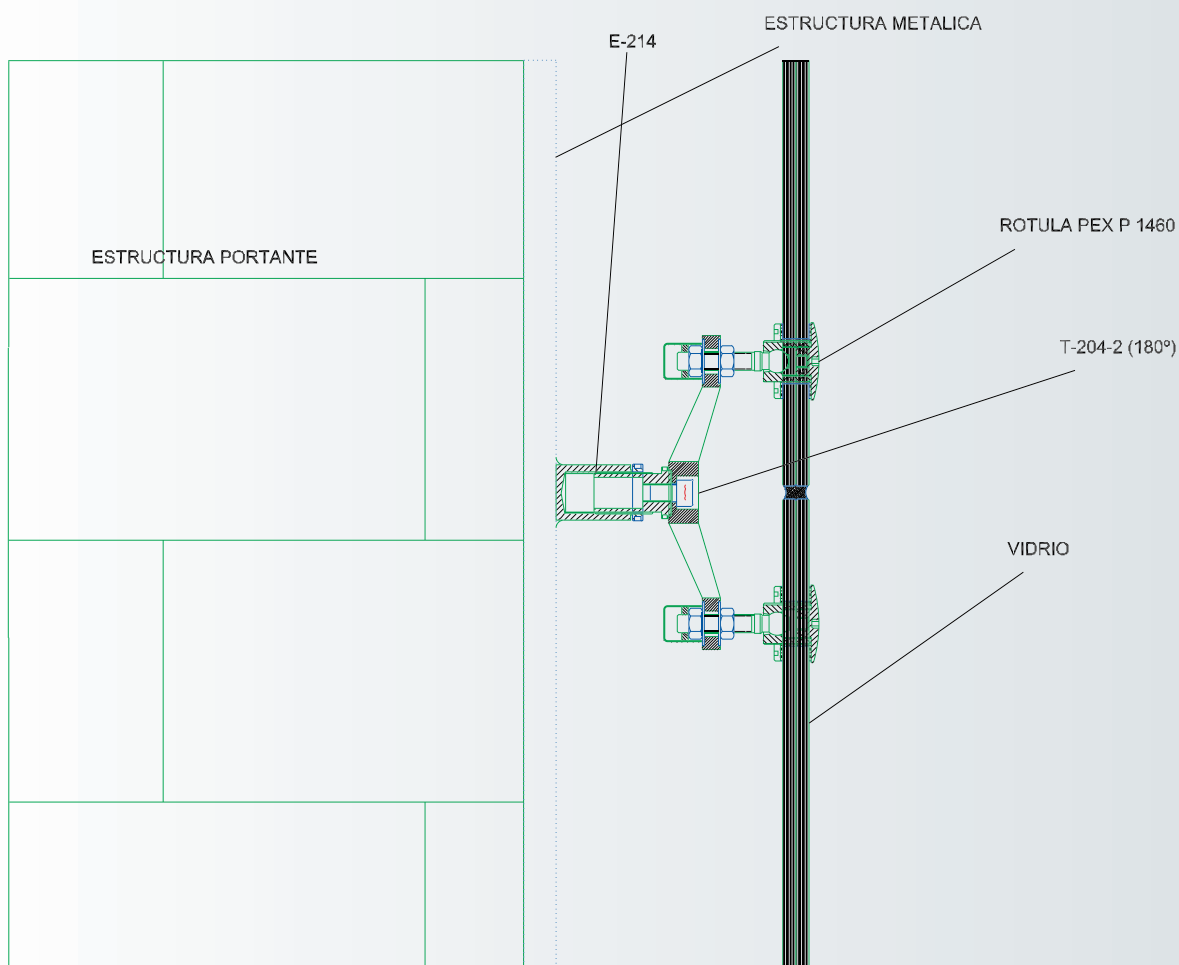

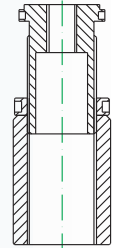
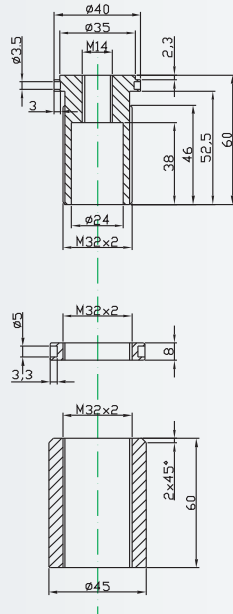

REF. E-214

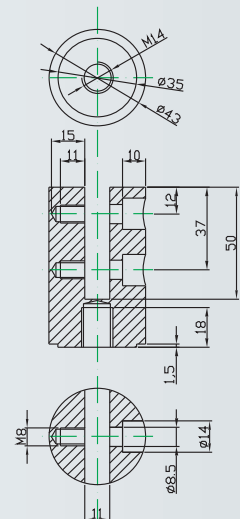
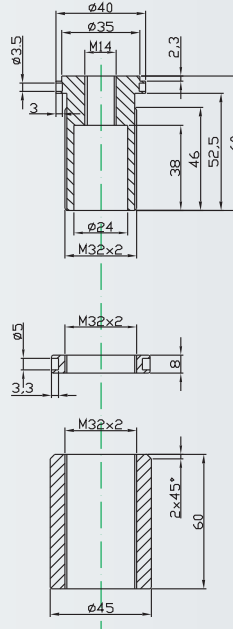

REF. E-215

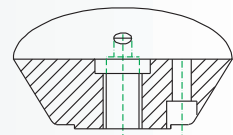
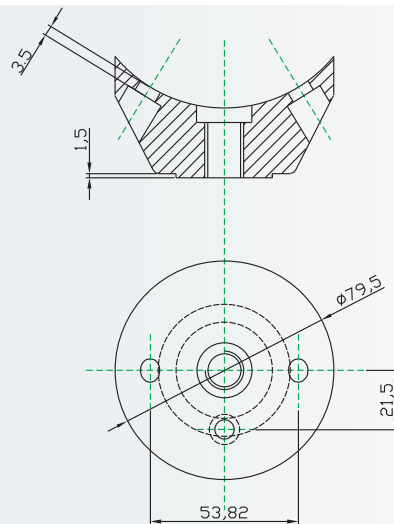
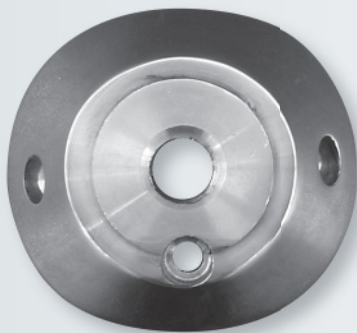

REF. E-216